

Universal Switching

Reduce Costs and Grow Revenues with Flexible and Future-proof Transport Switching

Network operators are faced with a wide range of options for the electrical switching layer of their transport networks, including OTN, MPLS-TP, Carrier Ethernet, and SONET/SDH. Each of these technologies has different strengths and optimal use cases. These diverse options have led many operators to deploy multiple transport switching technologies, each with its own platforms, thus increasing both CapEx and OpEx while compounding the challenges of delivering end-to-end services. Alternatively, operators with only one type of switching are restricted to a more limited set of transport services and may lack the flexibility to optimally adapt to changing traffic patterns and service demands. Infinera universal switching provides a flexible and future-proof solution to address these challenges.

INFINERA mTERA UNIVERSAL TRANSPORT PLATFORM

Available on the Infinera mTera Universal Transport Platform (UTP), universal switching enables the switching of OTN, packet, and SONET/SDH natively over universal fabrics. The mTera OSM modules provide the ability to define each interface, and even virtual interface, for any of the following switching types:

- OTN switching
- MPLS-TP: VPWS
- MPLS-TP: VPLS and H-VPLS
- Carrier Ethernet (CE): VLAN cross-connect (VLAN XC)
- Carrier Ethernet (CE): Bridging

SONET/SDH switching is offered by the mTera SSM-2S module together with the universal fabrics. Interworking between these different switching types is also supported, as shown in Table 1, enabling multiple value-added hybrid switching applications.

BENEFITS OF INFINERA UNIVERSAL SWITCHING

- **Adapt** to changing traffic patterns and service demands with the ability to define any interface/virtual interface for OTN switching, MPLS-TP, or Carrier Ethernet switching
- **Minimize** OpEx and CapEx by consolidating OTN, packet, and SONET/SDH switching on a single highly flexible platform
- **Reduce** 100G+ interface costs with efficient native grooming of OTN, packet, and SONET/SDH onto the same high speed wavelength
- **Grow** revenues with end-to-end services that span multiple different transport domains and by extending packet switched services to nonpacket edge devices
- **Maximize** the value of IP router investments with efficient aggregation and by offloading Layer 2 services

Switching Types	OTN	MPLS-TP: VPWS	MPLS-TP: VPLS	CE: VLAN XC	CE: Bridging	SONET/SDH
OTN	N/A	✓	✓	✓	✓	✓
MPLS-TP: VPWS	✓	N/A	✓	✓	✓	✓
MPLS-TP: VPLS	✓	✓	N/A	✓	✓	✓
CE: VLAN XC	✓	✓	✓	N/A	✓	✓
CE: Bridging	✓	✓	✓	✓	N/A	✓
SONET/SDH	✓	✓	✓	✓	✓	N/A

TABLE 1 — Infinera Universal Switching: Interworking Between Switching Types

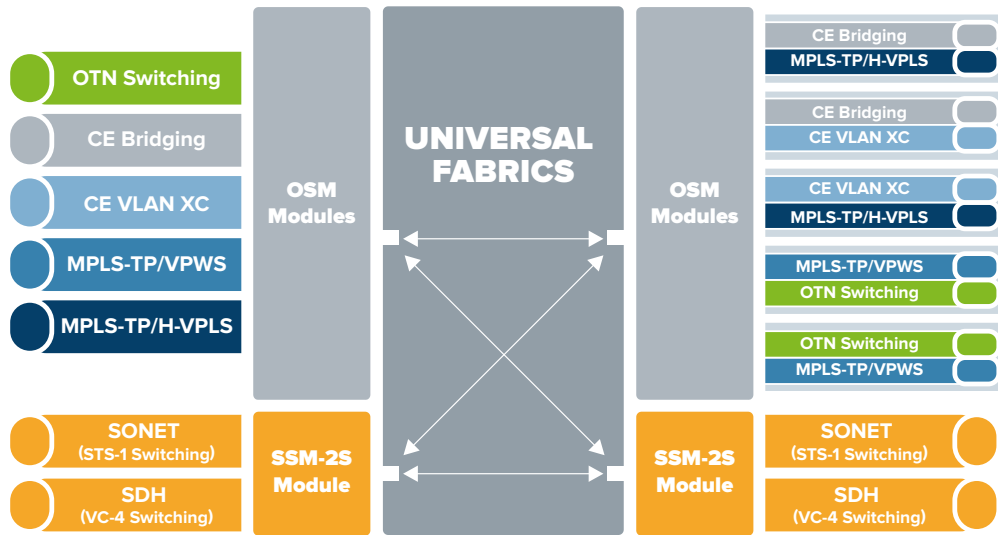

Figure 1: Universal Switching in the mTera UTP

OFFERING OTN, PACKET, AND SONET/SDH SWITCHED SERVICES ON A SINGLE PLATFORM

Infinera universal switching enables a single platform to provide switching for OTN, SONET/SDH, and the multiple flavors of packet switching. These different switching types can be supported simultaneously. Sharing the same common equipment, fabrics, interface modules, and even interfaces results in significant savings in terms of CapEx, footprint, and power consumption relative to the alternative of multiple single technology switches. Additional savings occur with a reduced number of network elements to install, manage, and maintain and fewer spares to purchase and inventory. Furthermore, the ability to reassign physical resources between switching types enables network operators to quickly respond to changes in traffic patterns and to quickly provision new services as their customers' requirements evolve. For example, the same physical hardware could be used to first deliver TDM leased lines, then as the customer's needs evolve, these resources could be repurposed to deliver Ethernet services providing additional revenues without the need for additional CapEx.

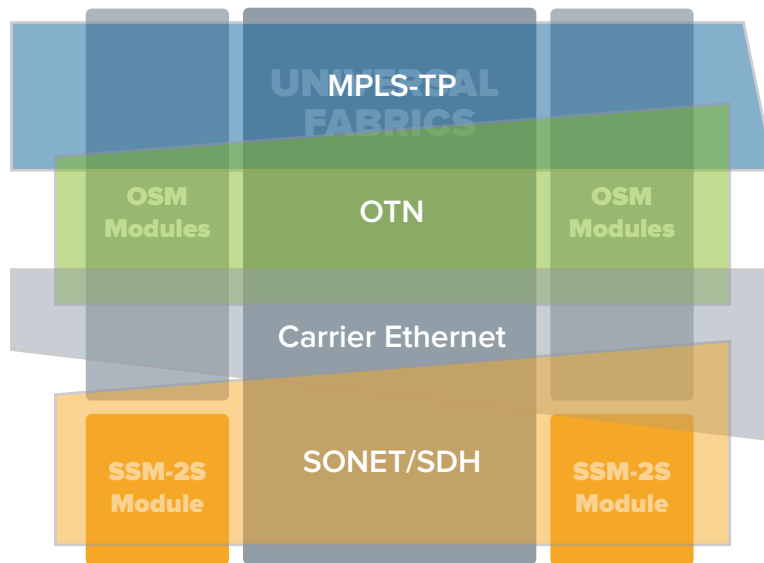

Figure 2: Simultaneous OTN, Packet, and SONET/SDH Switching

REDUCING 100G+ INTERFACE COSTS WITH OTN, PACKET, AND SONET/SDH SWITCHING ON THE SAME WAVELENGTH

100G+ DWDM interfaces typically represent the most expensive part of any DWDM network. Minimizing the number of 100G+ wavelengths also has significant benefits in terms of spectral efficiency and prolonging the life of optical layer assets. The ability to map packet switched and SONET/SDH switched traffic alongside OTN traffic into ODUks enables the same 100G+ DWDM interface to carry multiple switching types, and delivers significant benefits over using individual wavelengths for each switching type. And while an OTN switch can also support different client protocols on the same wavelength, universal switching is engineered to enable the more efficient switching of each protocol in its native format at each universal switch.

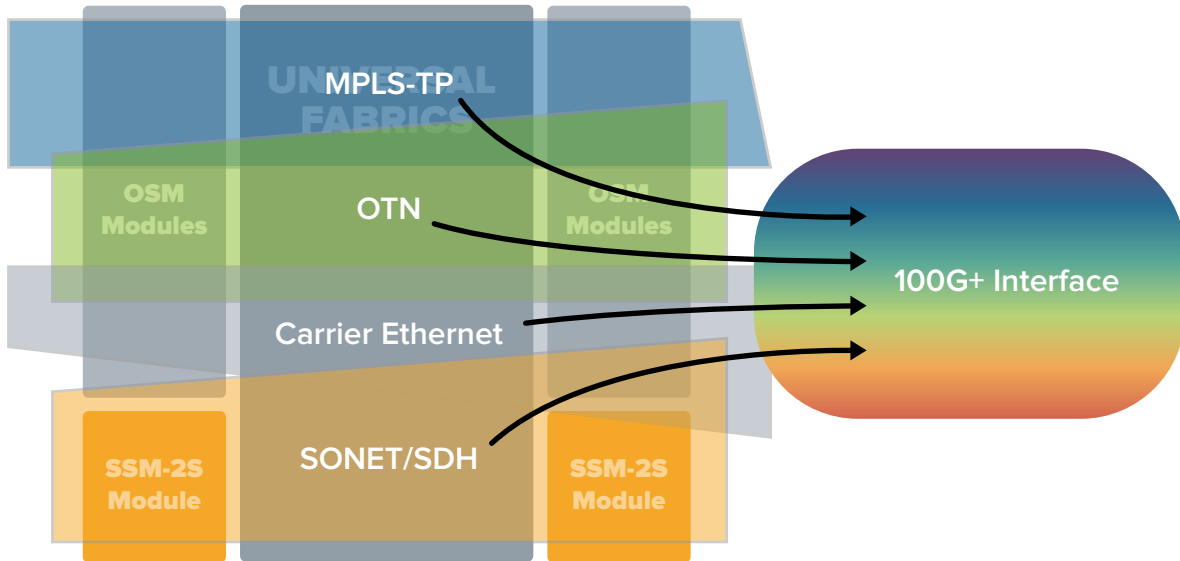

Figure 3: OTN, Packet, & SONET/SDH Switching Sharing the Same High Speed Wavelength

The ability of universal switching to reduce 100G+ interface costs and increase spectral efficiency is demonstrated in Table 2, which compares three scenarios with different switching technologies:

- Scenario 1: Multiple switches each dedicated to a separate technology
- Scenario 2: OTN only switching for all service types
- Scenario 3: A single universal switch for all service types

Point-to-point (P2P) traffic is modeled between two sites with the following service requirements:

- 80 x STM-1/OC-3
- 50 Gbps of OTN traffic
- 60 Gbps of packet traffic with 3:1 statistical gain

Switching Scenarios		Scenario 1	Scenario 2	Scenario 3
		Multiple Switches (OTN, packet, SONET/SDH)	OTN Switch (for all services)	Universal Switch (for all services)
P2P Traffic Requirements	SONET/SDH 80xSTM-1/OC-3	12.4 Gbps via SONET/SDH switch	100 Gbps (80xODU0)	12.4 Gbps
	OTN: 50 Gbps (5xODU2)	50 Gbps via OTN switch	50 Gbps	50 Gbps
	Packet: 20xGbE + 40x500Mbps + 2x10GE with 3:1 Stat Gain	20 Gbps (60 Gbps/3) via packet switch	60xODU0 + 2xODU2 = 100 Gbps	20 Gbps (60 Gbps/3)
Resources	Network Elements (2 sites)	6 (100%)	2 (33%)	2 (33%)
	100G Interfaces (2 sites)	6 (100%)	6 (100%)	2 (33%)
	100G Wavelengths	3 (100%)	3 (100%)	1 (33%)
	Spectrum	150 GHz (100%)	150 GHz (100%)	50 GHz (33%)

TABLE 2 — 100G Interfaces: Multiple Switches vs. OTN Switch vs. Universal Switch

Scenario 1 requires three switches per site (one OTN switch, one packet switch, and one SONET/SDH switch), each requiring a 100G wavelength, since different switching types cannot be mixed on the same wavelength. Scenario 2 provides the ability to mix different services into a single OTN switch and into shared wavelengths, but it requires 250 Gbps with the less efficient mapping of sub-GbE packet and STM-1s/OC-3s to ODU0s and a lack of statistical gain for the packet traffic. So while the OTN switching scenario, as with the universal switching scenario, reduces the number of network elements by a factor of three, OTN switching still requires six 100G interfaces and three wavelengths. Universal switching benefits from the granularity of native switching and the statistical gains of packet. This efficiency combined with the ability to mix different traffic switching types on the same wavelength is designed to reduce the number of 100G interfaces, the number of wavelengths, and the spectrum required by a factor of three.

DELIVERING END-TO-END SERVICES THAT SPAN MULTIPLE DIFFERENT SWITCHING DOMAINS

Many network operators have deployed different switching technologies in different parts of their network, where the strengths of that switching type provided the best fit with the requirements of that part of the network. Many operators also have large installed bases of legacy equipment such as SONET/SDH, which are still delivering revenue-generating services. Other operators have accumulated a mix of transport switching technologies through mergers and acquisitions.

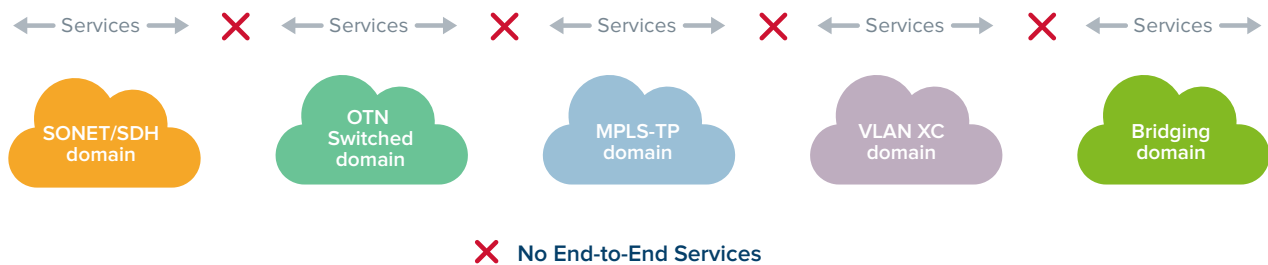

Figure 4: No Universal Switching Option A: Service Islands

Without universal switching, network operators have two options. Option A is to accept the loss of revenues that may come from an inability to offer end-to-end services as shown in Figure 4. Option B is to stitch together end-to-end services with physical interconnects between back-to-back switches of different types as shown in Figure 5. For example, end-to-end Ethernet services could be created with physical Ethernet interconnects between the SONET/SDH switch/ADM and the OTN switch, then with Ethernet interconnects between the OTN switch and the MPLS-TP switch, and so on. However, this approach is complex, does not scale well, and leads to slow service activation especially when new physical interconnects are required.

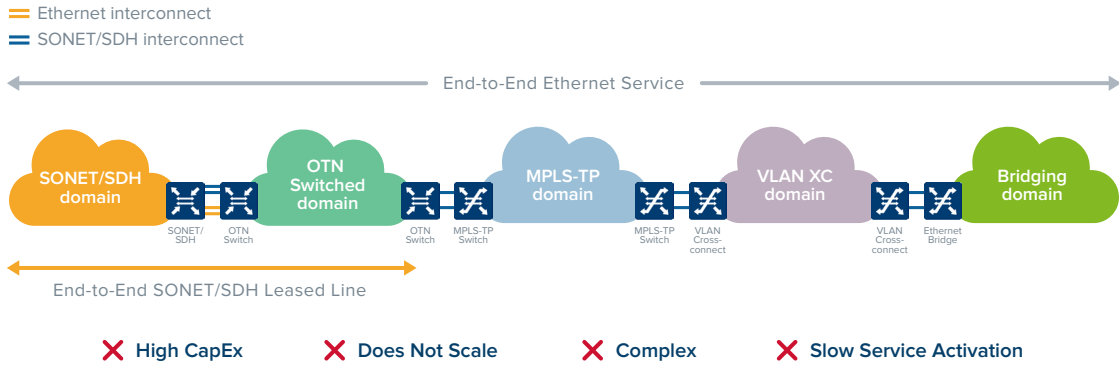

Figure 5: No Universal Switching Option B: Back-to-back Interconnects

Universal switching is designed to provide the ability to offer end-to-end services that span the multiple transport switching domains without back-to-back interconnects, and provides operators with an opportunity to grow revenues without significant additional CapEx. This functionality is enabled by the interworking capabilities of Infinera universal switching as shown in Table 1.

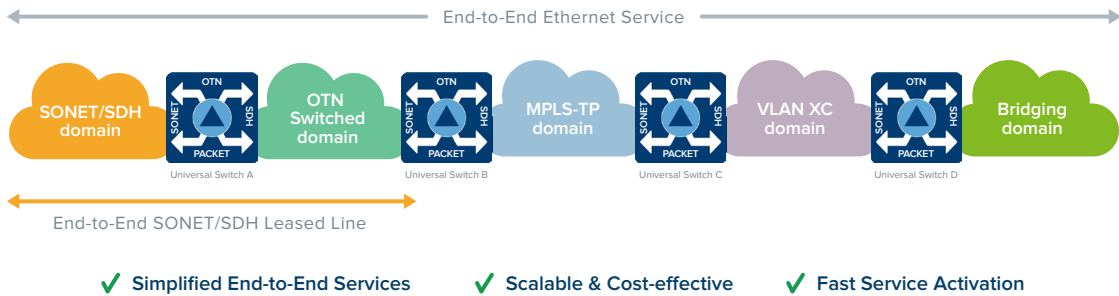

Figure 6: End-to-end Services Across Multiple Domains with Universal Switching

For example, as shown in Figure 6, an end-to-end Ethernet service starting as Ethernet over SONET/SDH could be first transported over a SONET/SDH domain. Then at Universal Switch A, the Ethernet is extracted from SONET/SDH and mapped directly to OTN for transport over the OTN domain. At Universal Switch B, the Ethernet is extracted from OTN and switched to MPLS-TP for transport over the MPLS-TP domain. Universal Switches C and D provide the same function for transport over the VLAN cross-connect and bridging domains respectively.

MAXIMIZING THE VALUE OF IP ROUTER INVESTMENTS WITH EFFICIENT AGGREGATION AND LAYER 2 SERVICE OFFLOAD

Infinera universal switching provides network operators with several opportunities to maximize the value of their investments in IP routers. Where OTN switching is used for transport to, from, and between IP routers, universal switching OTN/packet interworking enables the grooming of ODUs from a large number of locations onto a smaller number of high speed Ethernet ports.

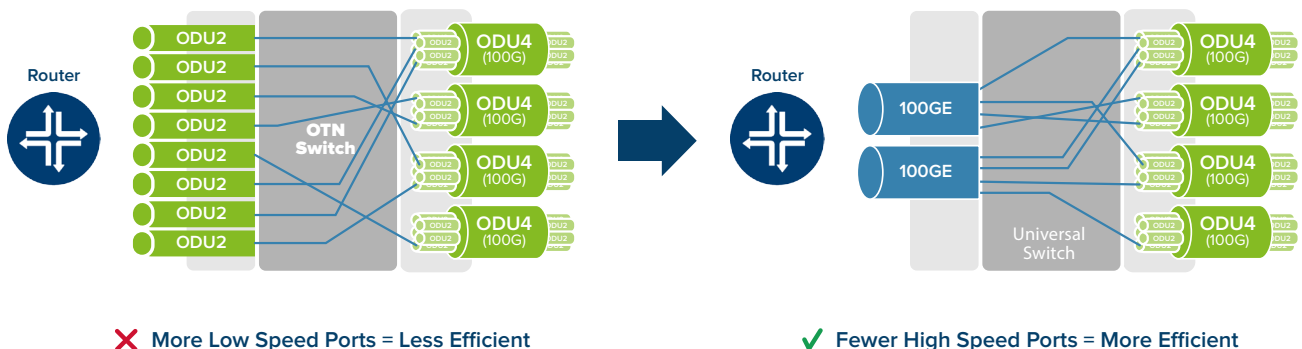

Figure 7: Aggregation onto High Speed Ethernet Ports with OTN/Packet Switching

		OTN Switch	Universal Switch	Savings
Traffic	10 Locations @ 10 Gbps	10 x 10GE ports	100 Gbps	
	20 Locations @ 5 Gbps	20 x 10GE ports	100 Gbps	
Resources	Router Ports	30 x 10GE SFP+	2 x 100GE	
	Relative Port Costs ¹	30 x 1 = 30	20 x 10 = 20	33%
	Power Consumption	30 W (1 W per SFP+)	7 W (3.5 W per QSFP28)	77%
	Pluggable Footprint	30 x 165mm ² = 4,950mm ²	2 x 250mm ² = 500mm ²	90%

1. Assumes price per bit parity between 10GE and 100GE ports

TABLE 3 — Router Support Efficiency: OTN Switch vs. Universal Switch

As the example in Table 3 illustrates, universal switching provides significant savings in terms of CapEx, power consumption, and footprint. In this example, a router has 10 Gbps (i.e., ODU2) to/from ten locations and 5 Gbps (with ODUflex) to/from twenty locations. A traditional OTN switch would require thirty 10GE ports on both the OTN switch and the router, while a universal switch would require only two 100GE ports on itself and the router. If we assume price per bit parity between the 10G ports and 100G ports, this will result in CapEx savings of 33 percent. While other factors will also have an impact, power consumption and footprint savings can be illustrated by comparing the power consumption and faceplate area of the pluggables. If we assume SFP+ pluggables for 10GE and QSFP28 for 100GE, power consumption savings are around 77 percent and footprint savings are approximately 90 percent.

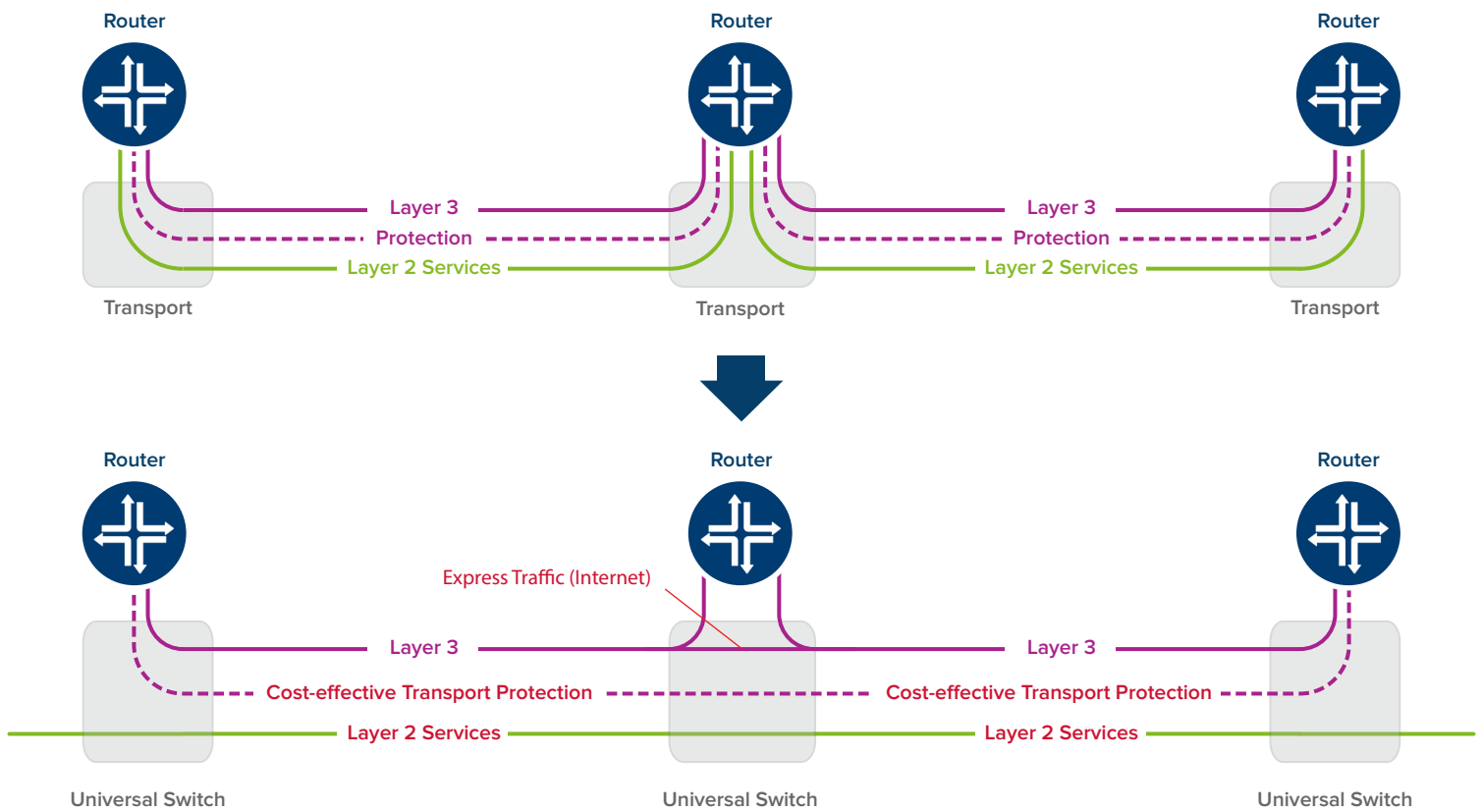

Figure 8: Maximizing Router Efficiency with Layer 2 Offload, Internet Express, and Transport Protection

Router efficiency can be further enhanced by offloading traffic that does not require IP processing at any particular node, as shown in Figure 8. Examples include Layer 2 Ethernet services that can be delivered more cost effectively with universal switching and internet traffic that can be expressed between the edge router and the internet router with intermediate IP processing adding little value. Universal switching can also provide cost-effective options for traffic protection and further save valuable router ports.

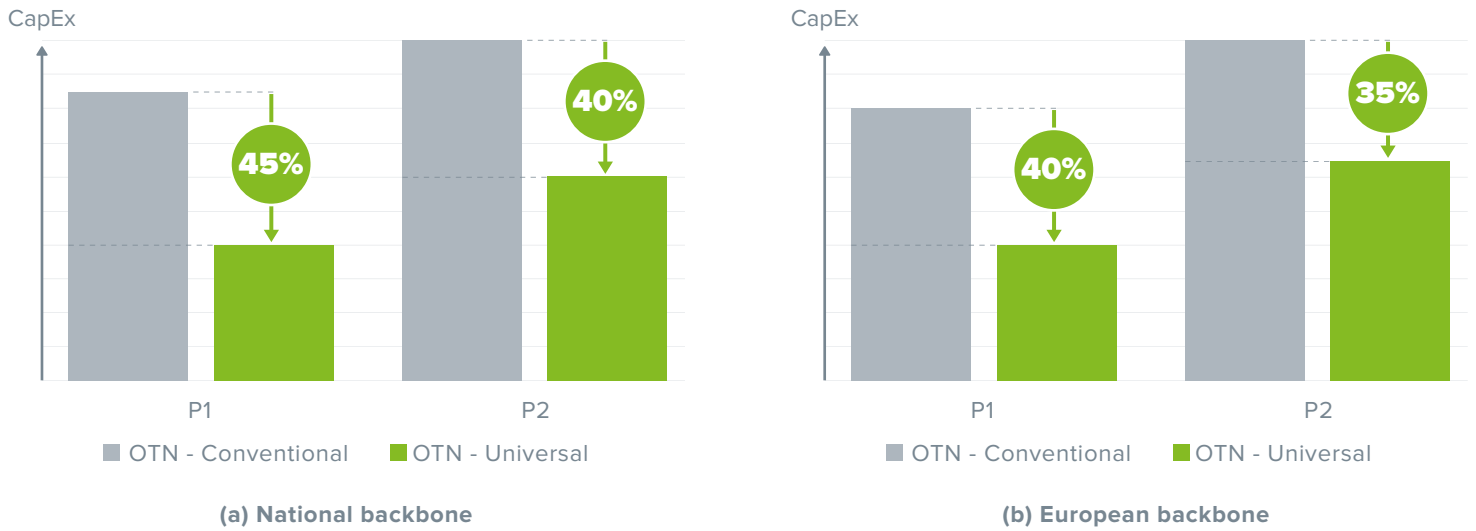

Figure 9: Tier 1 Study Showing Router Savings with Infinera Universal Switching

The scale of router cost savings possible with universal switching was demonstrated by a recent real-world study of a Tier 1 operator's national and pan-European backbones, with the two periods (P1 and P2 in Figure 9) representing a doubling of traffic over four years. In this study, Infinera universal switching provided CapEx savings of between 35 percent and 45 percent over OTN-only switches with the savings coming from the more efficient use of router ports and, to a lesser extent, reduced numbers of 100G line interfaces.

EXTENDING PACKET SWITCHED SERVICES TO NONPACKET EDGE DEVICES

The number of nodes at the network edge is typical orders of magnitude higher than at hub locations. This makes the deployment of nonpacket devices such as OTN muxponders or OTN ADMs attractive due to their low cost and simplified configuration and management relative to more complex packet devices.

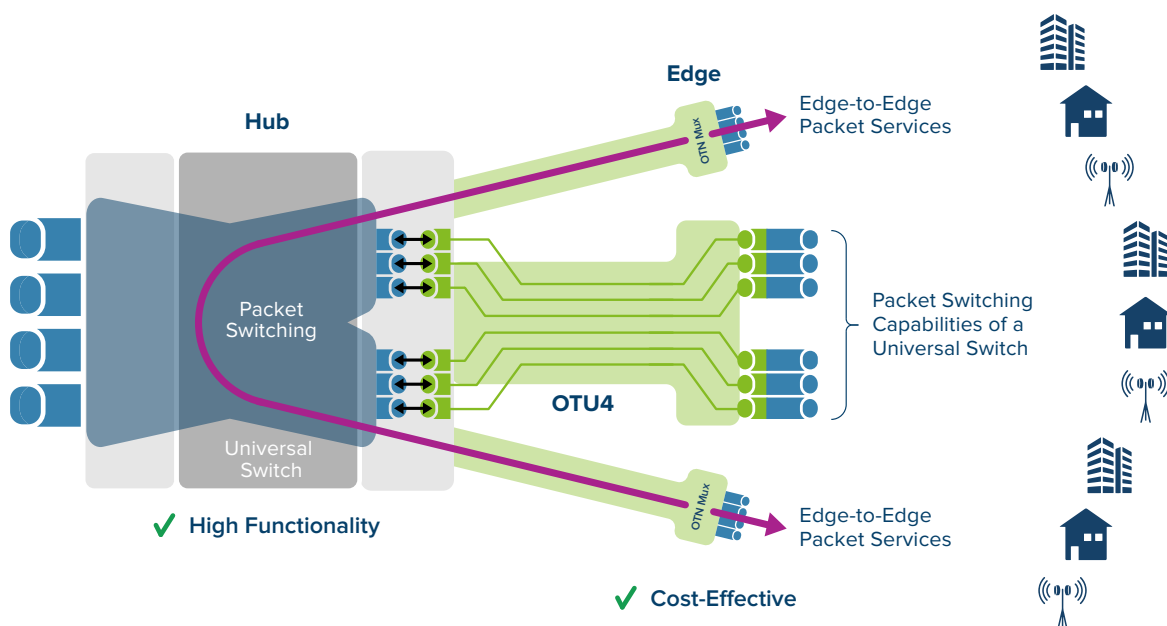

Figure 10: Extending Packet Switching to Nonpacket Edge Devices

However, the majority of services delivered at the network edge are now packet-based. Universal switching enables network operators to cost effectively extend packet switching services to these nonpacket edge devices. As demonstrated in Figure 10, packet traffic is mapped to ODUks on the OTN muxponder before being transported to the universal switch. At the hub site, these ODUks are terminated and packet traffic is mapped to virtual ports of the packet switching instance in the universal switch. In this way, the packet switching capabilities of the universal switch can be extended to the remote nonpacket device. Ports on the nonpacket edge device can now appear to support packet capabilities such as link aggregation and switching between ports (via the centralized universal switch).

Hub	Universal	OTN	Packet	Packet
Edge	OTN	OTN	OTN	Packet
Statistical Gain at Hub	✓	X	✓	✓
Simplified Edge Operations	✓	✓	✓	X
No Back-to-back Interconnects at Hub	✓	✓	X	✓
All Ethernet Services	✓	EPL only	✓	✓
End-to-end TDM Services	✓	✓	X	X

TABLE 4 — Alternatives to Universal Hub + OTN Edge

As shown in Table 4, relative to the alternative of OTN at both the hub and edge, this approach benefits from greater scalability at the hub site with the statistical gain of packet and the ability to offer a full suite of Ethernet services, including EVPL and ELAN services. The alternative of a packet-only switch at the hub site with OTN at the edge would require muxponders at the hub to demultiplex the OTN with back-to-back physical Ethernet interconnects to the packet switch, which would increase costs and limit scalability. This alternative would also not be able to support TDM services. As discussed previously, deploying packet at both the hub and edge increases the operational complexity at the edge while also not supporting TDM services.

SUMMARY

Infinera universal switching is designed to enable multiple switching types to share the same hardware and the same 100G+ interfaces, thus saving CapEx and reducing OpEx while also increasing agility and spectral efficiency. In addition, universal switching can be used to cost effectively extend end-to-end services over multiple different transport domains and to extend packet switched services to nonpacket edge devices, both providing opportunities to grow revenues without significant additional CapEx. Universal switching can maximize the value of IP router investments by effectively aggregating traffic onto a smaller number of high speed ports, offloading Layer 2 Ethernet services and pass-through traffic, and delivering more cost-effective transport layer protection.